



Established 1784
Bramah



**BRAMAH - KAYE
ENGLISH MORTICE LOCKS**

BRAMAH - KAYE MORTICE LOCKS

The Bramah - Kaye range of English Mortice Door Locks are made in England

Bramah + Bramah - Kaye

Bramah is a **specialist lock manufacturer** known for the manufacture of high quality, high security deadlocks and rim cylinders since 1784.

The addition of the Bramah - Kaye range of products **enhances the solutions** Bramah is able to offer its customers, while continuing to offer products that will last the test of time.

The Bramah - Kaye Range

The Range comprises a single size lock case designed to provide the full range of functionality required in **domestic** or **commercial** situations, while being operated by most brands of Euro Profile Union Oval and Swiss Profile cylinders as well as Handles and or Escutcheons of your choice.

It is a **truly open lock system**, allowing most brands of cylinders and handles to be mixed and matched.

Functions

The most common forms of functionality include :-

Latch - (Page 4)

Nightlatch - (Pages 5-6) suitable for use with an Electric Release and an Access Control System.

Escape Nightlatch - (Pages 7-8) suitable for use with an Electric Release, Emergency Escape and an Access Control System.

Deadlock - (Page 9)

Sash Lock - (Page 10)

Escape Sash Lock - (Page 11)

Bathroom Lock - (Page 12)

Key/Cylinder Options

When being used with a **Bramah key** the Swiss Profile Option must be used, when being used with **Bramah - Evva key**, the Euro Profile or Oval Option must be used.

BRAMAH - KAYE MORTICE LOCKS

Important - When handles are being used with a single plate to also cover the cylinder, the following measurements are critical :-

- **Euro Profile** - Handle to profile centre - **49.30 mm**
- **Union Oval** - Handle to profile centre - **48.50 mm**
- **Swiss Profile** - Handle to profile centre - **50.30 mm**

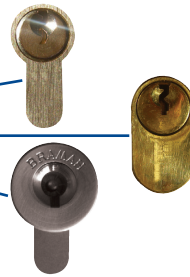

The Bramah - Kaye Lock Case Measurements

45 mm (1 3/4") Keyway Backset.

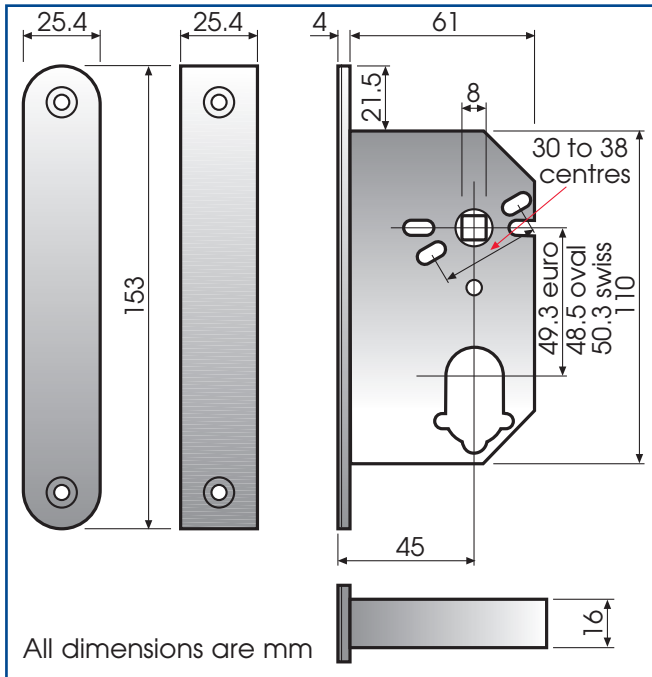

57 mm (2 1/4") Keyway Backset.

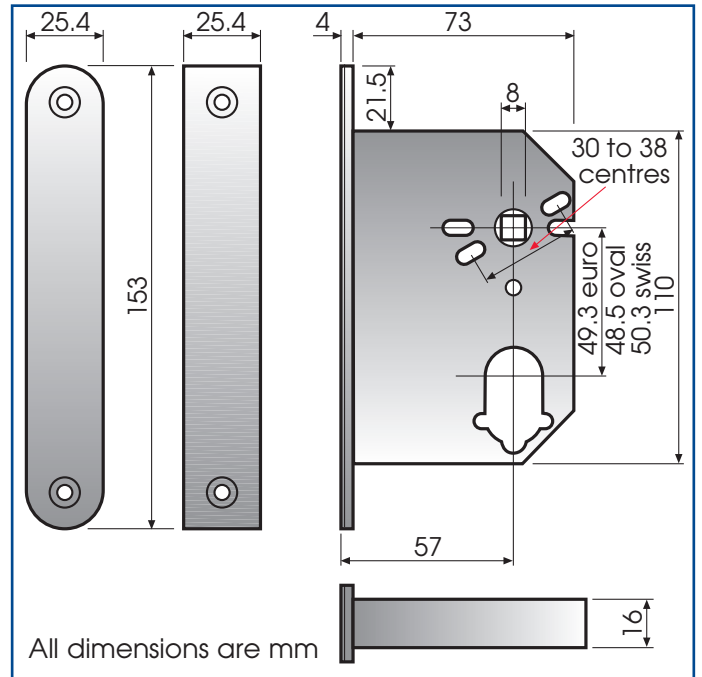

3000 Series (Different measurements for 2000 and 1000 exist)

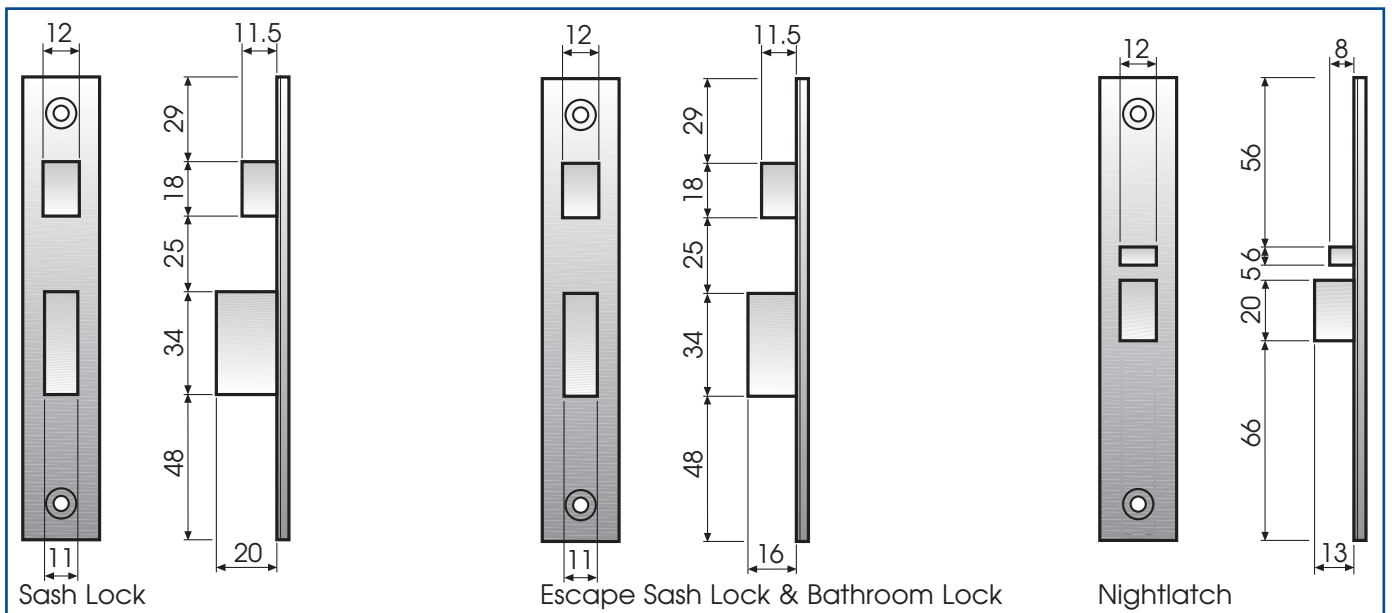

BRAMAH - KAYE MORTICE LOCKS

Product Types, Operation and Options

- Product Type:** Latch.
Purpose: To automatically hold the door closed, but not locked.
Cylinders Used: None.
Operation: O - Depress handle to open - Outside.
 I - Depress handle to open - Inside.

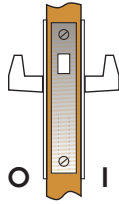

Options Available:

Square Faceplate - Use Round Faceplate with Rebated Doors				
Steel Finish		Bolt	Case	Backset
B8596-400-U	45mm Mortice Latch - 2098	11.5	65	45
B8573-400-U	57mm Mortice Latch - 2098	11.5	77	57
Brass Finish		Bolt	Case	Backset
B8596-410-U	45mm Mortice Latch - 2098	11.5	65	45
B8573-410-U	57mm Mortice Latch - 2098	11.5	77	57

Round Faceplate - Always with rebate sets - see table below				
Steel Finish		Bolt	Case	Backset
B8596-500-U	45mm Mortice Latch - 2098	11.5	65	45
B8573-500-U	57mm Mortice Latch - 2098	11.5	77	57
Brass Finish		Bolt	Case	Backset
B8596-510-U	45mm Mortice Latch - 2098	11.5	65	45
B8573-510-U	57mm Mortice Latch - 2098	11.5	77	57

Rebate Sets Available:

Anodised Steel Finish - Only Works with Round Faceplates	
B8494-753-A	12mm Rebate Set 2000 or 3000 Series Sash Deadlock Latch
B8494-754-A	19mm Rebate Set 2000 or 3000 Series Sash Deadlock Latch
B8494-755-A	25mm Rebate Set 2000 or 3000 Series Sash Deadlock Latch
Anodised Brass Finish - Only Works with Round Faceplates	
B8494-763-A	12mm Rebate Set 2000 or 3000 Series Sash Deadlock Latch
B8494-764-A	19mm Rebate Set 2000 or 3000 Series Sash Deadlock Latch
B8494-765-A	25mm Rebate Set 2000 or 3000 Series Sash Deadlock Latch

All dimensions are in millimetres



Mortice Latch

BRAMAH - KAYE MORTICE LOCKS

Product Types, Operation and Options

- Product Type:** Nightlatch with Snib.
Purpose: To automatically hold the door closed and deadlocked. To be used with Electric Release, Access Control and Door Closer.
Cylinders Used: Euro Profile (including Simons Voss), Union Oval, Bramah Profile.
Operation: O - Key to unlock and open - Outside.
 I - Key to unlock and open - Inside.

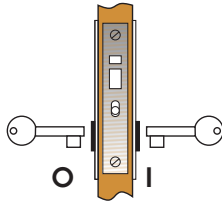

Options Available:

Square Faceplate - Use Round Faceplate with Rebated Doors					
Steel Finish		Bolt	Case	Backset	
B8534-400-U	57mm Mortice Nightlatch with Snib - 3084 - KK or KT	13	77	57	
B8003-400-U	57mm Mortice Nightlatch with Snib - 3084 - KK or KT 22 Swiss	13	77	57	
Brass Finish					
B8534-410-U	57mm Mortice Nightlatch with Snib - 3084 - KK or KT	13	77	57	
B8003-410-U	57mm Mortice Nightlatch with Snib - 3084 - KK or KT 22 Swiss	13	77	57	
Round Faceplate - Always with rebate sets - see table below					
Steel Finish		Bolt	Case	Backset	
B8534-500-U	57mm Mortice Nightlatch with Snib - 3084 - KK or KT	13	77	57	
B8003-500-U	57mm Mortice Nightlatch with Snib - 3084 - KK or KT 22 Swiss	13	77	57	
Brass Finish					
B8534-510-U	57mm Mortice Nightlatch with Snib - 3084 - KK or KT	13	77	57	
B8003-510-U	57mm Mortice Nightlatch with Snib - 3084 - KK or KT 22 Swiss	13	77	57	



Nightlatch with Snib

Rebate Sets Available:

Anodised Steel Finish - Only Works with Round Faceplates	
B8494-750-A	12mm Rebate Set 2000 or 3000 Series Nightlatch
B8494-751-A	19mm Rebate Set 2000 or 3000 Series Nightlatch
B8494-752-A	25mm Rebate Set 2000 or 3000 Series Nightlatch
Anodised Brass Finish - Only Works with Round Faceplates	
B8494-760-A	12mm Rebate Set 2000 or 3000 Series Nightlatch
B8494-761-A	19mm Rebate Set 2000 or 3000 Series Nightlatch
B8494-762-A	25mm Rebate Set 2000 or 3000 Series Nightlatch

All dimensions are in millimetres

BRAMAH - KAYE MORTICE LOCKS

Product Types, Operation and Options

- Product Type:** Nightlatch without Snib.
Purpose: To automatically hold the door closed and locked. To be used with Electric Release, Access Control and Door Closer.
Cylinders Used: Euro Profile (including Simons Voss), Union Oval, Bramah Profile.
Operation: O - Key to unlock and open - Outside.
 I - Key to unlock and open - Inside.

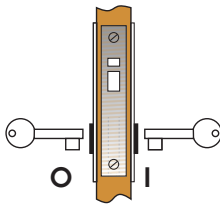

Options Available:

Square Faceplate - Use Round Faceplate with Rebated Doors				
Steel Finish		Bolt	Case	Backset
B8536-400-U	57mm Mortice Nightlatch without Snib - 3085 - KK or KT	13	77	57
B8004-400-U	57mm Mortice Nightlatch without Snib - 3085 - KK or KT 22 Swiss	13	77	57
Brass Finish				
B8536-410-U	57mm Mortice Nightlatch without Snib - 3085 - KK or KT	13	77	57
B8004-410-U	57mm Mortice Nightlatch without Snib - 3085 - KK or KT 22 Swiss	13	77	57
Round Faceplate - Always with rebate sets - see table below				
Steel Finish		Bolt	Case	Backset
B8536-500-U	57mm Mortice Nightlatch without Snib - 3085 - KK or KT	13	77	57
B8004-500-U	57mm Mortice Nightlatch without Snib - 3085 - KK or KT 22 Swiss	13	77	57
Brass Finish				
B8536-510-U	57mm Mortice Nightlatch without Snib - 3085 - KK or KT	13	77	57
B8004-510-U	57mm Mortice Nightlatch without Snib - 3085 - KK or KT 22 Swiss	13	77	57



Nightlatch without Snib

Rebate Sets Available:

Anodised Steel Finish - Only Works with Round Faceplates	
B8494-750-A	12mm Rebate Set 2000 or 3000 Series Nightlatch
B8494-751-A	19mm Rebate Set 2000 or 3000 Series Nightlatch
B8494-752-A	25mm Rebate Set 2000 or 3000 Series Nightlatch
Anodised Brass Finish - Only Works with Round Faceplates	
B8494-760-A	12mm Rebate Set 2000 or 3000 Series Nightlatch
B8494-761-A	19mm Rebate Set 2000 or 3000 Series Nightlatch
B8494-762-A	25mm Rebate Set 2000 or 3000 Series Nightlatch

All dimensions are in millimetres

BRAMAH - KAYE MORTICE LOCKS

Product Types, Operation and Options

- Product Type:** Escape Nightlatch with Snib.
Purpose: To automatically hold the door closed and locked while allowing immediate escape with handle. To be used with Electric Release, Access Control and Door Closer.
Cylinders Used: Euro Profile (including Simons Voss), Union Oval, Bramah Profile.
Operation: O - Key to unlock and open - Outside.
 I - Handle to unlock and open - Inside.

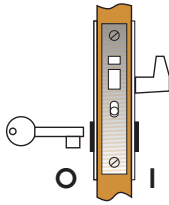

Options Available:

Square Faceplate - Use Round Faceplate with Rebated Doors				
Steel Finish		Bolt	Case	Backset
B8522-400-U	57mm Mortice Escape Nightlatch with Snib - 3062 - K	13	77	57
B8000-400-U	57mm Mortice Escape Nightlatch with Snib - 3062 - K 22 Swiss	13	77	57
Brass Finish				
B8522-410-U	57mm Mortice Escape Nightlatch with Snib - 3062 - K	13	77	57
B8000-410-U	57mm Mortice Escape Nightlatch with Snib - 3062 - K 22 Swiss	13	77	57
Round Faceplate - Always with rebate sets - see table below				
Steel Finish		Bolt	Case	Backset
B8522-500-U	57mm Mortice Escape Nightlatch with Snib - 3062 - K	13	77	57
B8000-500-U	57mm Mortice Escape Nightlatch with Snib - 3062 - K 22 Swiss	13	77	57
Brass Finish				
B8522-510-U	57mm Mortice Escape Nightlatch with Snib - 3062 - K	13	77	57
B8000-510-U	57mm Mortice Escape Nightlatch with Snib - 3062 - K 22 Swiss	13	77	57



Escape Nightlatch with Snib

Rebate Sets Available:

Anodised Steel Finish - Only Works with Round Faceplates	
B8494-750-A	12mm Rebate Set 2000 or 3000 Series Nightlatch
B8494-751-A	19mm Rebate Set 2000 or 3000 Series Nightlatch
B8494-752-A	25mm Rebate Set 2000 or 3000 Series Nightlatch
Anodised Brass Finish - Only Works with Round Faceplates	
B8494-760-A	12mm Rebate Set 2000 or 3000 Series Nightlatch
B8494-761-A	19mm Rebate Set 2000 or 3000 Series Nightlatch
B8494-762-A	25mm Rebate Set 2000 or 3000 Series Nightlatch

All dimensions are in millimetres

BRAMAH - KAYE MORTICE LOCKS

Product Types, Operation and Options

Product Type Escape Nightlatch without Snib.
Purpose: To automatically hold the door closed and locked while allowing immediate escape with handle. To be used with Electric Release, Access Control and Door Closer.

Cylinders Used: Euro Profile (including Simons Voss), Union Oval, Bramah Profile.

Operation: O - Key to unlock and open - Outside.
 I - Handle to unlock and open - Inside.

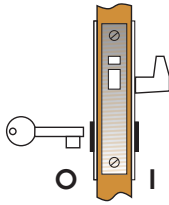

Options Available:

Square Faceplate - Use Round Faceplate with Rebated Doors					
Steel Finish			Bolt	Case	Backset
B8530-400-U	57mm Mortice Escape Nightlatch without Snib - 3061 - K		13	77	57
B8005-400-U	57mm Mortice Escape Nightlatch without Snib - 3061 - K 22 Swiss		13	77	57
Brass Finish					
B8530-410-U	57mm Mortice Escape Nightlatch without Snib - 3061 - K		13	77	57
B8005-410-U	57mm Mortice Escape Nightlatch without Snib - 3061 - K 22 Swiss		13	77	57

Round Faceplate - Always with rebate sets - see table below					
Steel Finish			Bolt	Case	Backset
B8530-500-U	57mm Mortice Escape Nightlatch with Snib - 3061 - K		13	77	57
B8005-500-U	57mm Mortice Escape Nightlatch without Snib - 3061 - K 22 Swiss		13	77	57
Brass Finish					
B8530-510-U	57mm Mortice Escape Nightlatch with Snib - 3061 - K		13	77	57
B8005-510-U	57mm Mortice Escape Nightlatch without Snib - 3061 - K 22 Swiss		13	77	57

Rebate Sets Available:

Anodised Steel Finish - Only Works with Round Faceplates	
B8494-750-A	12mm Rebate Set 2000 or 3000 Series Nightlatch
B8494-751-A	19mm Rebate Set 2000 or 3000 Series Nightlatch
B8494-752-A	25mm Rebate Set 2000 or 3000 Series Nightlatch
Anodised Brass Finish - Only Works with Round Faceplates	
B8494-760-A	12mm Rebate Set 2000 or 3000 Series Nightlatch
B8494-761-A	19mm Rebate Set 2000 or 3000 Series Nightlatch
B8494-762-A	25mm Rebate Set 2000 or 3000 Series Nightlatch

All dimensions are in millimetres



Escape Nightlatch without Snib

BRAMAH - KAYE MORTICE LOCKS

Product Types, Operation and Options

- Product Type:** Mortice Deadlock.
- Purpose:** To manually lock the door, from one or both sides. When unlocked the door will open when pushed.
- Cylinders Used:** Euro Profile (including Simons Voss), Union Oval, Bramah Profile.
- Operation:** O - Turn key to lock or unlock - Outside.
I - Turn key to lock or unlock - Inside.

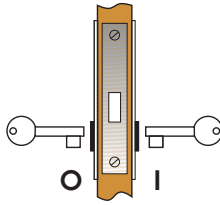

Options Available:

Square Faceplate - Use Round Faceplate with Rebated Doors				
Steel Finish		Bolt	Case	Backset
B8598-400-U	45mm Mortice Deadlock - 2088 - KK or KT	14	65	45
B8585-400-U	57mm Mortice Deadlock - 2088 - KK or KT	14	77	57
B8588-400-U	57mm Mortice Deadlock - 3088 - KK or KT	20	77	57
B8002-400-U	57mm Mortice Deadlock - 3088 - KK or KT 22 Swiss	20	77	57
Brass Finish				
B8598-410-U	45mm Mortice Deadlock - 2088 - KK or KT	14	65	45
B8585-410-U	57mm Mortice Deadlock - 2088 - KK or KT	14	77	57
B8588-410-U	57mm Mortice Deadlock - 3088 - KK or KT	20	77	57
B8002-410-U	57mm Mortice Deadlock - 3088 - KK or KT 22 Swiss	20	77	57

Round Faceplate - Always with rebate sets - see table below				
Steel Finish		Bolt	Case	Backset
B8598-500-U	45mm Mortice Deadlock - 2088 - KK or KT	14	65	45
B8585-500-U	57mm Mortice Deadlock - 2088 - KK or KT	14	77	57
B8588-500-U	57mm Mortice Deadlock - 3088 - KK or KT	20	77	57
B8002-500-U	57mm Mortice Deadlock - 3088 - KK or KT 22 Swiss	20	77	57
Brass Finish				
B8598-510-U	45mm Mortice Deadlock - 2088 - KK or KT	14	65	45
B8585-510-U	57mm Mortice Deadlock - 2088 - KK or KT	14	77	57
B8588-510-U	57mm Mortice Deadlock - 3088 - KK or KT	20	77	57
B8002-510-U	57mm Mortice Deadlock - 3088 - KK or KT 22 Swiss	20	77	57

Rebate Sets Available:

Anodised Steel Finish - Only Works with Round Faceplates	
B8494-753-A	12mm Rebate Set 2000 or 3000 Series Sash Deadlock Latch
B8494-754-A	19mm Rebate Set 2000 or 3000 Series Sash Deadlock Latch
B8494-755-A	25mm Rebate Set 2000 or 3000 Series Sash Deadlock Latch
Anodised Brass Finish - Only Works with Round Faceplates	
B8494-763-A	12mm Rebate Set 2000 or 3000 Series Sash Deadlock Latch
B8494-764-A	19mm Rebate Set 2000 or 3000 Series Sash Deadlock Latch
B8494-765-A	25mm Rebate Set 2000 or 3000 Series Sash Deadlock Latch

All dimensions are in millimetres



Mortice Deadlock

BRAMAH - KAYE MORTICE LOCKS

Product Types, Operation and Options

- Product Type:** Sash Lock.
- Purpose:** To automatically hold the door closed, while allowing a key to throw and withdraw the deadbolt and a handle to withdraw the latch.
- Cylinders Used:** Euro Profile, Union Oval, Bramah Profile.
- Operation:**
O - Depress Handle to open Latch. Turn key to lock or unlock - Outside.
I - Depress Handle to open Latch. Turn key to lock or unlock - Inside.

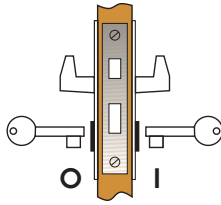

Options Available:

Square Faceplate - Use Round Faceplate with Rebated Doors				
Steel Finish		Bolt	Case	Backset
B8597-400-U	45mm Sash Lock - 2065 - KK or KT	14	65	45
B8584-400-U	57mm Sash Lock - 2065 - KK or KT	14	77	57
B8001-400-U	57mm Sash Lock - 3065 - KK or KT 22 Swiss	20	77	57
B8586-400-U	57mm Sash Lock - 3065 - KK or KT	20	77	57
Brass Finish		Bolt	Case	Backset
B8597-410-U	45mm Sash Lock - 2065 - KK or KT	14	65	45
B8584-410-U	57mm Sash Lock - 2065 - KK or KT	14	77	57
B8001-410-U	57mm Sash Lock - 3065 - KK or KT 22 Swiss	20	77	57
B8586-410-U	57mm Sash Lock - 3065 - KK or KT	20	77	57

Round Faceplate - Always with rebate sets - see table below				
Steel Finish		Bolt	Case	Backset
B8597-500-U	45mm Sash Lock - 2065 - KK or KT	14	65	45
B8584-500-U	57mm Sash Lock - 2065 - KK or KT	14	77	57
B8001-500-U	57mm Sash Lock - 3065 - KK or KT 22 Swiss	20	77	57
B8586-500-U	57mm Sash Lock - 3065 - KK or KT	20	77	57
Brass Finish		Bolt	Case	Backset
B8597-510-U	45mm Sash Lock - 2065 - KK or KT	14	65	45
B8584-510-U	57mm Sash Lock - 2065 - KK or KT	14	77	57
B8001-510-U	57mm Sash Lock - 3065 - KK or KT 22 Swiss	20	77	57
B8586-510-U	57mm Sash Lock - 3065 - KK or KT	20	77	57

Rebate Sets Available:

Anodised Steel Finish - Only Works with Round Faceplates	
B8494-753-A	12mm Rebate Set 2000 or 3000 Series Sash Deadlock Latch
B8494-754-A	19mm Rebate Set 2000 or 3000 Series Sash Deadlock Latch
B8494-755-A	25mm Rebate Set 2000 or 3000 Series Sash Deadlock Latch
Anodised Brass Finish - Only Works with Round Faceplates	
B8494-763-A	12mm Rebate Set 2000 or 3000 Series Sash Deadlock Latch
B8494-764-A	19mm Rebate Set 2000 or 3000 Series Sash Deadlock Latch
B8494-765-A	25mm Rebate Set 2000 or 3000 Series Sash Deadlock Latch

All dimensions are in millimetres



Sash Lock

BRAMAH - KAYE MORTICE LOCKS

Product Types, Operation and Options

Product Type: Escape Sash Lock.
Purpose: To automatically hold the door closed, while allowing a key to throw and withdraw the deadbolt but allowing, at all times, the internal handle to open the Latch and Deadbolt in one action, in accordance with fire safety requirements.
Cylinders Used: Euro Profile, Union Oval.

Operation: **O** - Depress Handle and/or turn Key to open or lock - Outside.
I - Depress Handle only to unlock. Key to lock - Inside.

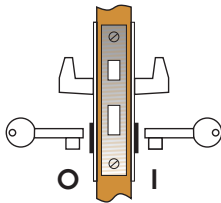

Options Available:

Square Faceplate - Use Round Faceplate with Rebated Doors				
Steel Finish				
B8526-400-I	57mm Escape Sash Lock - 3020R - K	Bolt	Case	Backset
B8526-400-O	57mm Escape Sash Lock - 3020L - K	16	77	57
Brass Finish				
B8526-410-I	57mm Escape Sash Lock - 3020R - K	16	77	57
B8526-410-O	57mm Escape Sash Lock - 3020L - K	16	77	57

Round Faceplate - Always with rebate sets - see table below				
Steel Finish				
B8526-500-I	57mm Escape Sash Lock - 3020R - K	Bolt	Case	Backset
B8526-500-O	57mm Escape Sash Lock - 3020L - K	16	77	57
Brass Finish				
B8526-510-I	57mm Escape Sash Lock - 3020R - K	16	77	57
B8526-510-O	57mm Escape Sash Lock - 3020L - K	16	77	57

Rebate Sets Available:

Anodised Steel Finish - Only Works with Round Faceplates	
B8494-753-A	12mm Rebate Set 2000 or 3000 Series Sash Deadlock Latch
B8494-754-A	19mm Rebate Set 2000 or 3000 Series Sash Deadlock Latch
B8494-755-A	25mm Rebate Set 2000 or 3000 Series Sash Deadlock Latch
Anodised Brass Finish - Only Works with Round Faceplates	
B8494-763-A	12mm Rebate Set 2000 or 3000 Series Sash Deadlock Latch
B8494-764-A	19mm Rebate Set 2000 or 3000 Series Sash Deadlock Latch
B8494-765-A	25mm Rebate Set 2000 or 3000 Series Sash Deadlock Latch

All dimensions are in millimetres



Escape Sash Lock

BRAMAH - KAYE MORTICE LOCKS

Product Types, Operation and Options

- Product Type:** Bathroom Lock.
- Purpose:** To automatically hold the door closed but not locked while allowing a knob on the inside to lock the door with an external indicator.
- Cylinders Used:** None.
- Operation:** **O** - Depress Handle to open - Outside.
I - Depress Handle to open, turn knob to lock or unlock - Inside.

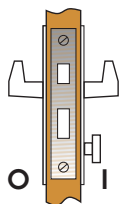

Options Available:

Square Faceplate - Use Round Faceplate with Rebated Doors				
Steel Finish		Bolt	Case	Backset
B8599-400-U	45mm Bathroom Lock - 2055T	14	65	45
B8572-400-U	57mm Bathroom Lock - 1055T	14	77	57
Brass Finish		Bolt	Case	Backset
B8599-410-U	45mm Bathroom Lock - 2055T	14	65	45
B8572-410-U	57mm Bathroom Lock - 1055T	14	77	57
Round Faceplate - Always with rebate sets - see table below				
Steel Finish		Bolt	Case	Backset
B8599-500-U	45mm Bathroom Lock - 2055T	14	65	45
B8572-500-U	57mm Bathroom Lock - 1055T	14	77	57
Brass Finish		Bolt	Case	Backset
B8599-510-U	45mm Bathroom Lock - 2055T	14	65	45
B8572-510-U	57mm Bathroom Lock - 1055T	14	77	57

All dimensions are in millimetres



Bathroom Lock

Rebate Sets Not Required

Bramah Security Equipment Limited

Marylebone - London - Sales Office and Trade Counter

31 Oldbury Place London W1U 5PT England
Telephone: +44 (0)8700 272624 Facsimile: +44 (0)20 7935 2779
Email:lock.sales@bramah.co.uk

Romford - Essex - Production and Trade Counter

19 Danes Road Romford Essex RM7 0HL England
Telephone: +44 (0)8080 027262 Facsimile: +44 (0)1708 768825
Email:manufacturing@bramah.co.uk

Web: www.bramah.co.uk

Hours of Business

Marylebone - Sales Office and Trade Counter

Monday to Friday 8.30am to 5.30pm Saturday 9.00am to 1.00pm

Romford - Trade Counter

Monday to Friday 8.00am to 4.30pm Earlier or Saturday by arrangement

Handing of Products

Right = 1

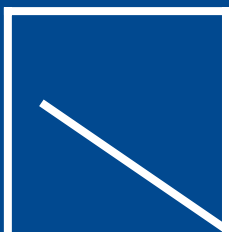

Left = 2



Right = 3



Left = 4

